



The Leader in Architectural Audio™

PN. 33-3025

INTRODUCTION

Thank you for purchasing Symphony Extreme TR series in-ceiling speakers. When properly installed, this product will provide you with years of entertainment pleasure.

To obtain the full potential of your new speakers, please read all instructions before starting the installation. If you do not have the necessary skills to install the speakers yourself, contact your authorized Sonance dealer for installation options.

PARTS LIST Extreme XTR

Each Extreme XTR speaker includes the following items:

- (2) Sonance Extreme XTR speakers
- (2) Paintable grilles
- (2) Plastic paint plugs to protect speakers during painting
- (1) Mounting cutout template (in packaging)

PARTS LIST Extreme XSSTR

Each Extreme XSSTR speaker includes the following items:

- (1) Sonance Extreme XSSTR speaker
- (1) Paintable grille
- (1) Plastic paint plug to protect speaker during painting
- (1) Mounting cutout template (in packaging)

OPTIONAL ACCESSORIES

FlexBracket - part number 90-1315

Plastic template to reserve hole in new construction. Designed to be used with the Roto-lock™ mounting system.

Staple Template - part number 90-1049

Thin plastic template for new construction to reserve hole in new construction. Designed to be used with the Roto-lock™ mounting system.

Coverplate - part number 90-0643

Designed to cover hole made by FlexBracket or Staple Template until the speaker is installed.

Adapter Ring - part number 90-0768

A plastic ring used to cover a 13" diameter hole produced by low grade commercial speakers.

Acoustic Enclosure - part number 91688

A 3/4" medium density fiberboard enclosure designed specifically for the CR and Symphony series speakers.

Fire Rate Back Can - part number 91710

A metal can designed for the CR and Symphony series speakers that meets the following fire testing criteria; ASTM E119, CAN/ULC S101, NFPA 251, UBC 7-1, UL 263.

INSTALLATION INSTRUCTIONS

SONANCE SYMPHONY EXTREME TR SERIES

DISTRIBUTED AUDIO PLACEMENT

The Sonance Symphony Extreme TR series speakers possess extremely smooth and predictable off-axis frequency response. The chart below shows how far apart the speakers can be placed in a distributed audio system. The calculations are based on +/- 45 degrees of coverage from the speaker, and listener ear heights of 62" for standing and 40" for seated.

Speaker spacing in feet for a distributed audio system		
	Standing Listener	Seated Listener
8 foot ceiling	5.7'	9.5'
10 foot ceiling	9.7'	13.5'
12 foot ceiling	13.7'	17.5'
14 foot ceiling	17.7'	21.5'

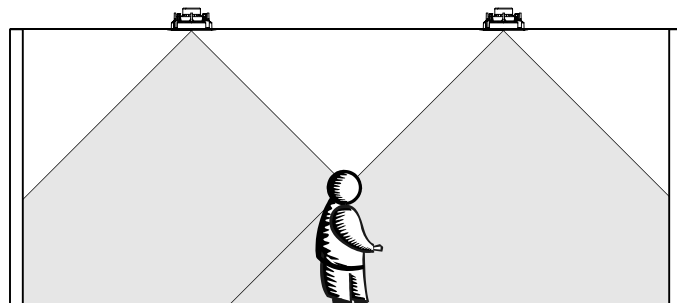

Distributed Audio Placement

2 - CHANNEL AUDIO PLACEMENT

In a standard two channel audio system, the Extreme TR series speakers should be separated approximately 6 to 10 feet apart. If possible, the left and right speakers should be located the same distance from the listening position.

ENVIRONMENTAL SPECIFICATIONS

Maximum Heat

104 degrees C = (220.0 degrees Fahrenheit)

Maximum Cold

-40 degrees C = (-40.0 degrees Fahrenheit)

Maximum Humidity and Temperature

99% humidity @ 49 degrees C = (120.0 degrees Fahrenheit)

95% humidity @ -40 degrees C = (-40.0 degrees Fahrenheit)

The Extreme speakers meet or exceed the following:

Salt Spray - ASTM-B117

UV Test - ASTM-G23H

IEC / CEE Water Splashing Test - IP-X4

Vibration Test - ASTM D5112-98 and ASTM D3580-95

WIRE GAUGE AND QUALITY

The total wire resistance should be less than 10% of the speaker impedance. If using an 8 ohm speaker, your total wire resistance should be no more than 0.8 ohms.

In simple terms, the extra resistance from the wire will have a very negative effect on the sound quality of the speaker. The sound can be less dynamic, definition of bass frequencies can be reduced, and in extreme cases, the high frequencies can be attenuated. Amplifier power is also wasted in the wire, reducing the maximum output level of the system.

Please refer to the following chart when deciding on the appropriate wire gauge for your installation.

Wire resistance in Ohms vs. length of cable run						
Distance in Feet	50'	100'	150'	200'	250'	300'
20 gauge	.86	1.73	2.59	3.45	4.32	5.18
18 gauge	.65	1.30	1.94	2.59	3.24	3.89
16 gauge	.43	.85	1.28	1.71	2.14	2.56
14 gauge	.27	.54	.81	1.08	1.35	1.62
12 gauge	.17	.34	.51	.68	.85	1.02
10 gauge	.11	.22	.33	.44	.56	.67

PREPARING THE INSTALLATION LOCATION

All Sonance speakers are designed to be relatively insensitive to changes in enclosure volume. To achieve the ultimate performance from the Extreme TR series speakers, a section of the ceiling bay can be sectioned off to form a back box. Building this enclosure will create a dramatic improvement in the quality of bass response and power handling.

Back box volume requirements:

XTR	1.00 cubic feet (28.3 liters)
XSSTR	1.00 cubic feet (28.3 liters)

Insulating the ceiling cavity

Speaker performance can be enhanced by insulating the cavity with fiberglass insulation.

When installing speakers in a ceiling, it is best to lay a sheet of unfaced fiberglass insulation over the back of the speaker.

To further improve the sound quality, install insulation in the bays adjacent to the speaker location. This will reduce noise produced by the unsupported drywall.

Sonafill®

Sonafill is a retrofitable acoustical treatment for loudspeakers that virtually eliminates the noise produced by resonating drywall and dramatically improves mid-bass sound quality. Sonafill also reduces room-to-room noise especially in multi-channel installations where many speakers are installed.

The Sonafill system consists of two pillows and four tiles. Installation is accomplished by first adhering the tiles to the inside of the cavity, then stuffing the two pillows in place behind the tiles.

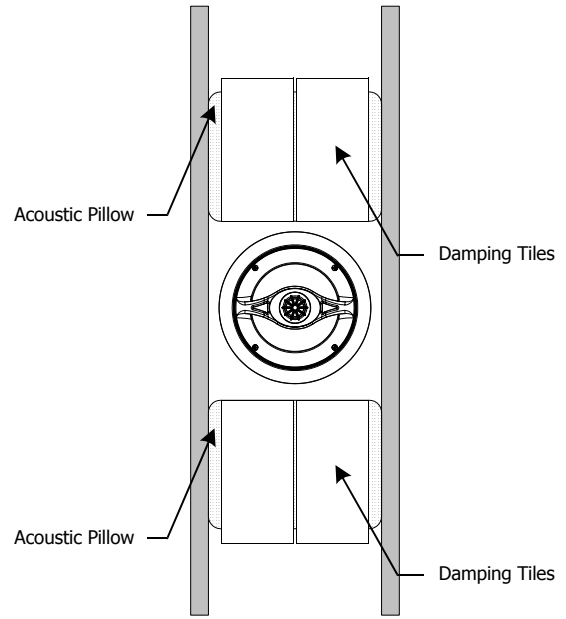
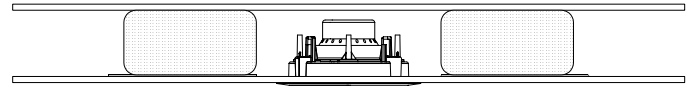

The Sonafill System

New Construction

The Extreme TR series speakers feature an integral Roto-Lock™ mounting system for quick mounting into ceilings. The Symphony / CR series FlexBracket is only necessary in new construction installations when reserving a location for the speaker is desired.

The FlexBracket will serve as a guide for the drywall when cutting holes for in-ceiling speakers. The FlexBracket is nailed or screwed to the joists so that the hole is in the desired location once the drywall is installed.

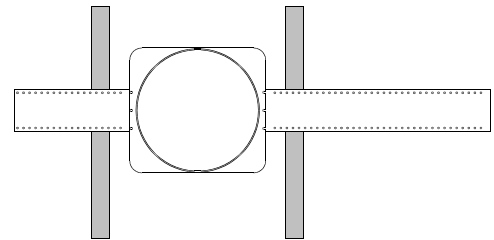

Symphony / CR series FlexBracket

Retrofit

With the Roto-Lock system, the speaker can be installed directly into existing ceilings. Once the hole is cut and the cable is run, the speakers can be installed in a matter of seconds.

Once you have determined the area you would like to locate your speakers, you will need to do an obstruction survey. Before you cut the hole for the speaker, be certain no joist, conduit, pipe, heating duct or air return will interfere with the speaker.

The Extreme TR series speakers require a hole that is 8 5/32" in diameter.

A cut-out template is provided in the packaging of the speaker. Position the template where the speaker is to be located and pencil an outline on the ceiling. If you are unsure about obstructions, drill a small hole in the center of the circle and insert a coat hanger into the hole to feel for possible obstructions. If no obstructions are found, proceed with cutting the hole using a drywall saw and run the speaker wires.

INSTALLING THE SPEAKERS

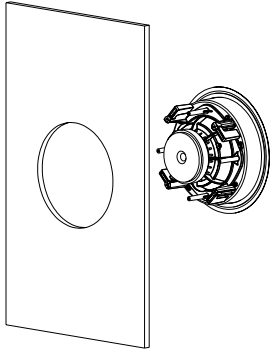

Step 1

Remove the paint plug from the speaker. Attach the wire from your amplifier to the terminals on the back of the speaker. Double check the polarity of the speaker wires, amplifier + to speaker + and amplifier - to speaker -. Proper polarity is critical in home theater installations.

Note: See Connecting the XSSTR for proper connection of this speaker.

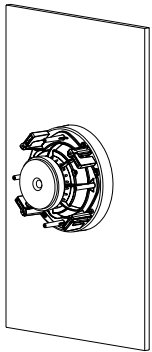

Step 2

Make sure the Roto-Lock clamps are in the full clockwise position so that all the clamps are tucked within the cutout border. Insert the speaker into the hole in the ceiling.

Note: The maximum clamp thickness is 1-1/4" (32mm)

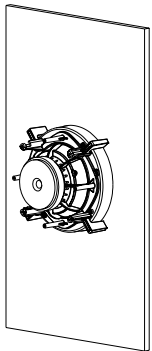

Step 3

Tighten the four screws on the front of the baffle. The Roto-Lock clamps will rotate into position automatically and begin clamping. When you notice resistance on the four screws, the speaker has been clamped successfully.

The flange is designed to flex and conform to any small imperfections in the wall surface. The screws should not be tightened so far that the flange bows out.

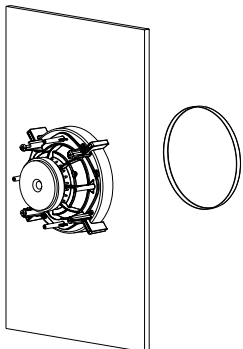

Step 4

After the speaker is installed, and all the adjustments shown to the right are completed, the grille can be installed. Insert about half of the grille into the groove at the edge of the speaker. Gently fit the remaining half of the grill into the speaker by working your hands around the speaker fitting the grille into the groove as you go along.

Note: The torque applied to the mounting screws can be adjusted for proper grille fit.

CONNECTING THE XSSTR SPEAKER

The XSSTR produces the left and right audio signal from one speaker. The crossover on the back of the speaker, shown below, features two pairs of push-to-connect terminals.

You can connect the left and right signal to either pair of terminals. Make sure when you connect this speaker that you do not combine or mix up the positive and negative wires from each channel. Damage may occur to your receiver or amplifier if the wires are not connected correctly.

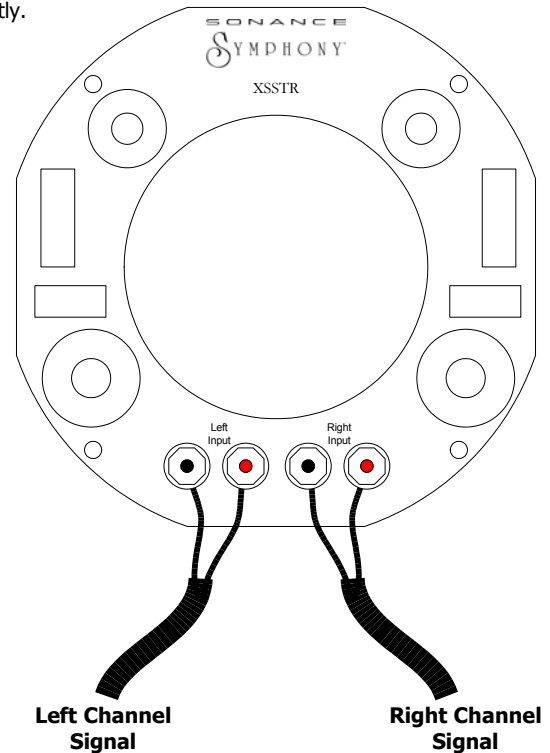

PAINTING THE SPEAKERS AND GRILLES

Speakers and grilles can be painted before installation, which will eliminate the "paint scar" if the speaker needs to be removed for service. Speakers may also be painted after installation, but before the grilles are attached. All speakers come from the factory fitted with a plastic "paint plug." Use the paint plug to protect the drivers while the flange is being painted with the ceiling.

Sonance suggests always painting the grilles separate from the speaker. The grilles may be lightly sprayed with thin paint (5 parts thinning agent to 1 part paint), but be careful not to plug the holes. Too much paint will adversely affect the sound of the speaker.

Once the grilles and flange are painted and dry, remove the paint plug from the flange and install the grilles.

Extreme XTR

Tweeter	1.0" (25mm) Polyurethane dome
Woofer	6-1/2" (165mm) Black anodized aluminum cone with a rubber surround
Frequency Response	55Hz - 20kHz + 3dB
Impedance	8 ohms nominal - 6 ohms minimum
Power Handling	5 - 60 Watts
SPL	89 dB
Grille	Powder coated Stainless steel
Dimensions DxD	9-3/4" (248mm) x 3-5/8" (92mm)
Cutout Dim D	8-5/32" (207mm)
Shipping Weight	9 lbs (4.1 KG) per pair

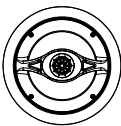

Extreme XSSTR

Tweeter	Two 1.0" (25mm) Polyurethane domes
Woofer	6-1/2" (165mm) Dual voice coil, black anodized aluminum cone with a rubber surround
Frequency Response	55Hz - 20kHz + 3dB
Impedance	8 ohms nominal - 6 ohms minimum
Power Handling	5 - 60 Watts
SPL	89 dB
Grille	Powder coated Stainless steel
Dimensions DxD	9-3/4" (248mm) x 5-3/16" (132mm)
Cutout Dim D	8-5/32" (207mm)
Shipping Weight	4.5 lbs (2.1 KG) each



TECHNICAL ASSISTANCE AND SERVICE

The Technical Assistance Department at Sonance is available at (800) 582-0772 or (949) 492-7777 to answer any questions concerning the operation and installation of your speakers between the hours of 7:00 AM and 5:00 PM Pacific time, Monday through Friday, except holidays.

In the event your unit should need repair or service, you may return the unit to your authorized dealer or use the following guidelines:

1. Be prepared to state the model number and / or serial number, date of purchase and dealer's name and address when calling.
2. Contact Sonance directly at (800) 582-0772 or (949) 492-7777 or at www.sonance.com
3. If you are returning the product directly to Sonance, call us to obtain a return authorization number before shipping. **YOU MUST HAVE PRIOR AUTHORIZATION TO RETURN YOUR UNIT.**
4. The original packaging must be used. If the original packaging is unavailable, replacements can be obtained from Sonance for a small fee.
5. Ship the product via United Parcel Service, Federal Express, or RPS. Please do not use the U.S. Mail service.
6. Write the return authorization number on the outside of the box.
7. Ship to:
Attn: Quality Assurance Department
Sonance
212 Avenida Fabricante
San Clemente, CA 92672-7531
8. **FREIGHT COLLECT SHIPMENTS WILL BE REFUSED !**

WARRANTY COVERAGE (U.S. ONLY)

If, within five (5) years from the date shown on the bill of sale, the unit fails due to a defect in workmanship or material, Sonance will, at its option and at no charge, repair or replace the components of such unit which prove to be defective. For this warranty to be effective, the bill of sale must show that the unit was purchased from an "Authorized Sonance Dealer". This warranty shall apply exclusively to the original purchaser and shall not apply to units purchased for industrial or commercial use.

Furthermore, this warranty shall not apply if:

1. Damage to the unit was caused by accident, abuse or misuse;
2. The unit was opened, modified, or repaired by unauthorized personnel.
3. The unit was not used as outlined in the operating instructions.

EXCLUSIONS AND LIMITATIONS

The warranty set forth above is in lieu of all other warranties, expressed or implied, of merchantability, fitness for a particular purpose, or otherwise. The warranty is limited to Sonance products registered herein and specifically excludes any damage to loudspeakers and other allied or associated equipment which may result for any reason from use with this product. Sonance shall in no event be liable for incidental or consequential damages arising from any breach of this warranty or otherwise. This warranty gives you specific legal rights, and you may have rights which vary from state to state.

w w w . s o n a n c e . c o m